

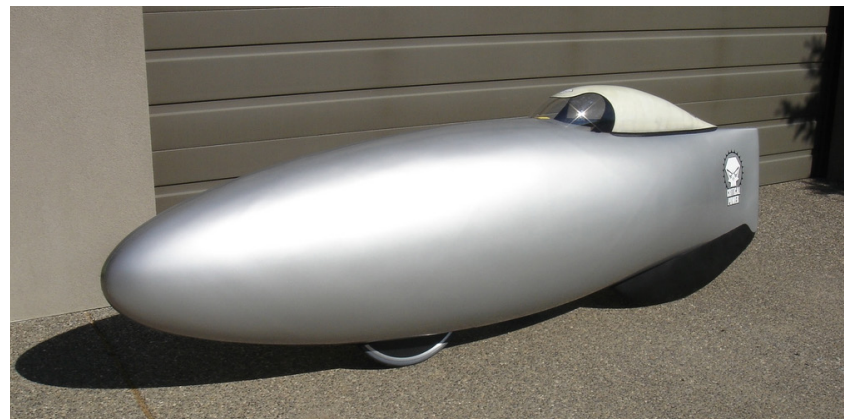

Mood Board - User and Setting

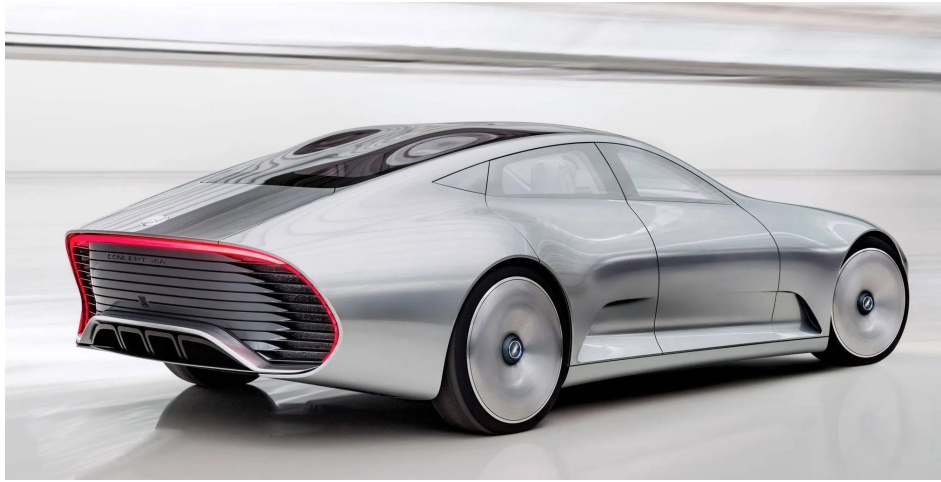

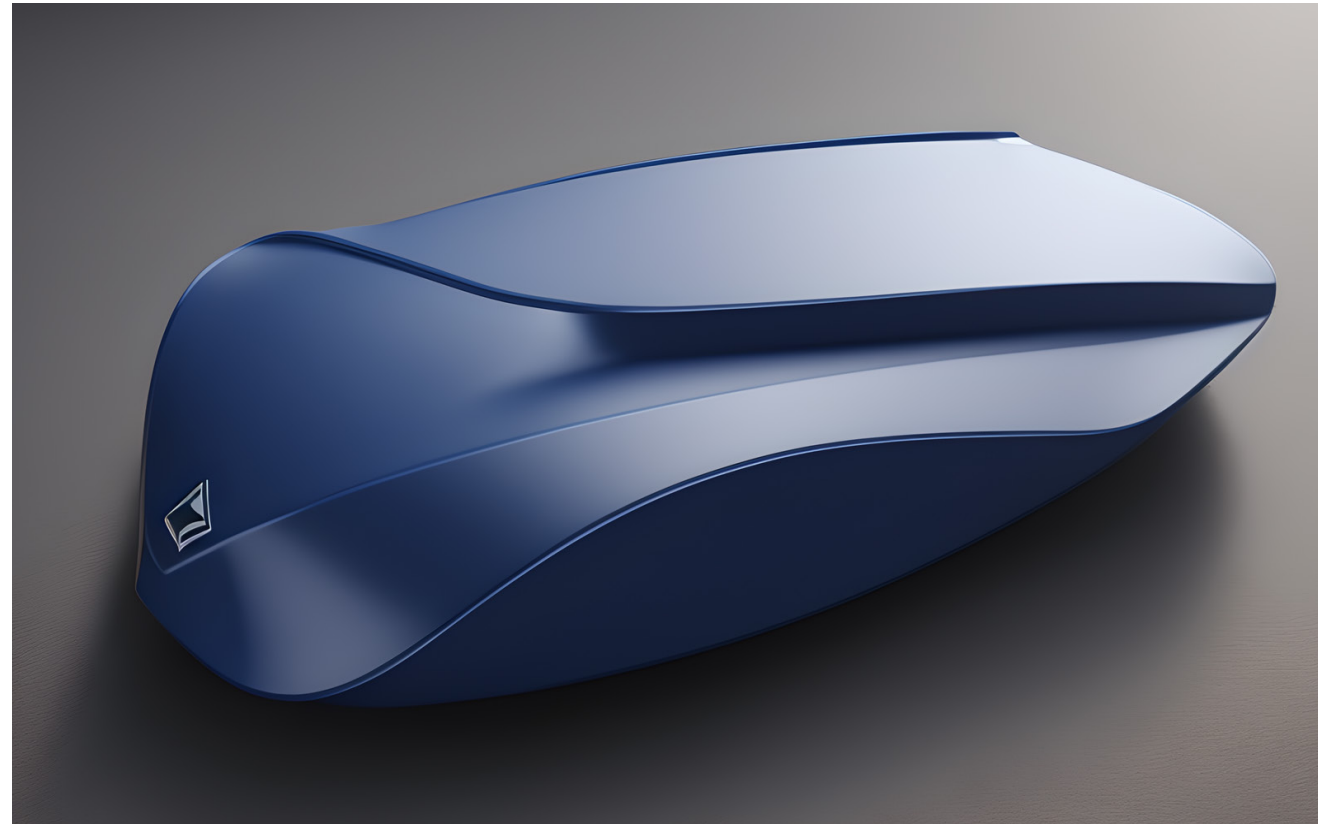

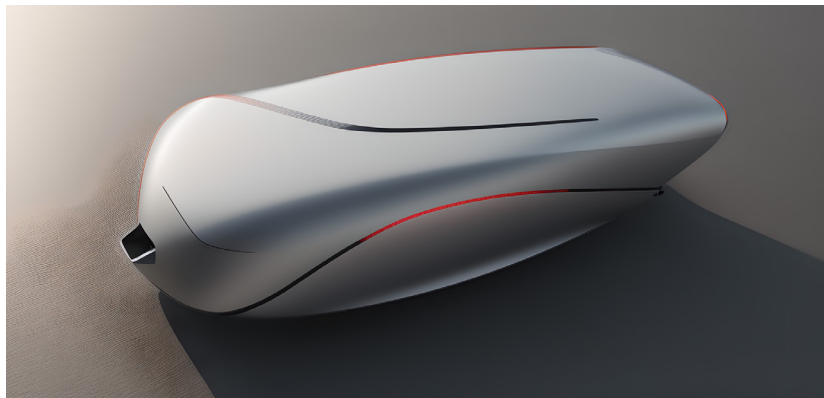
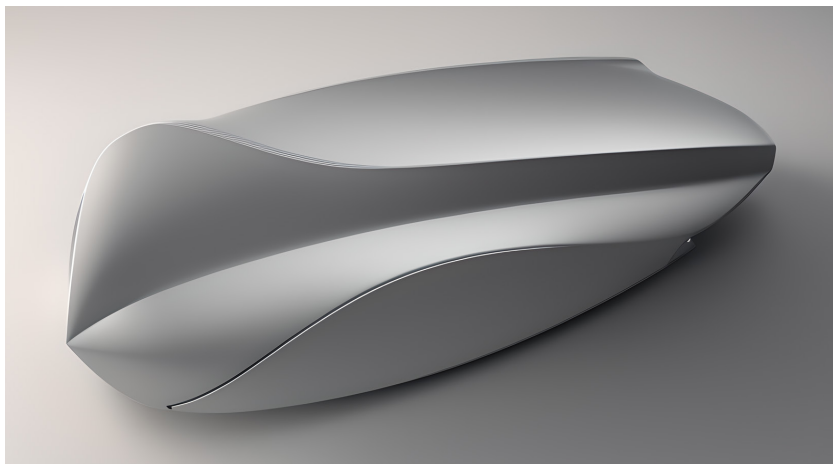
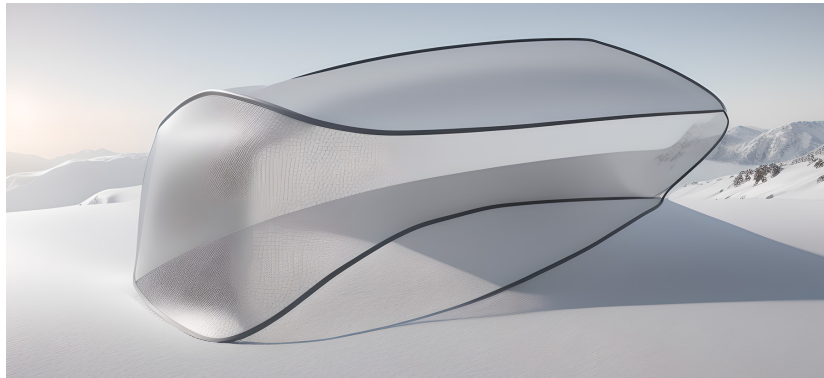
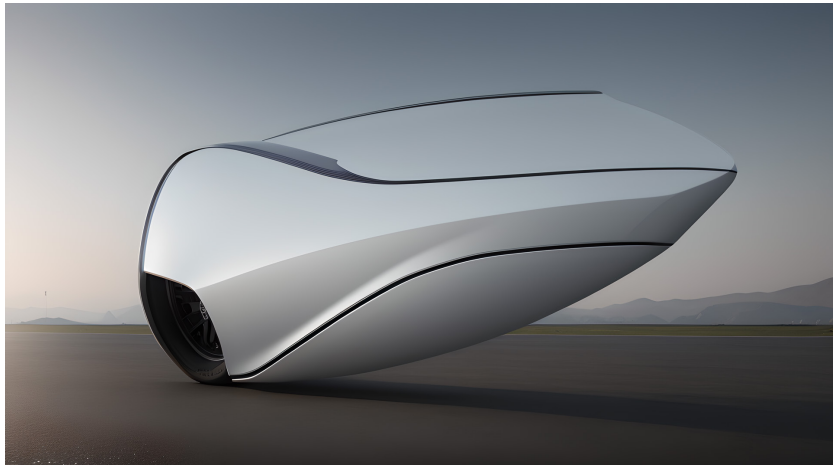

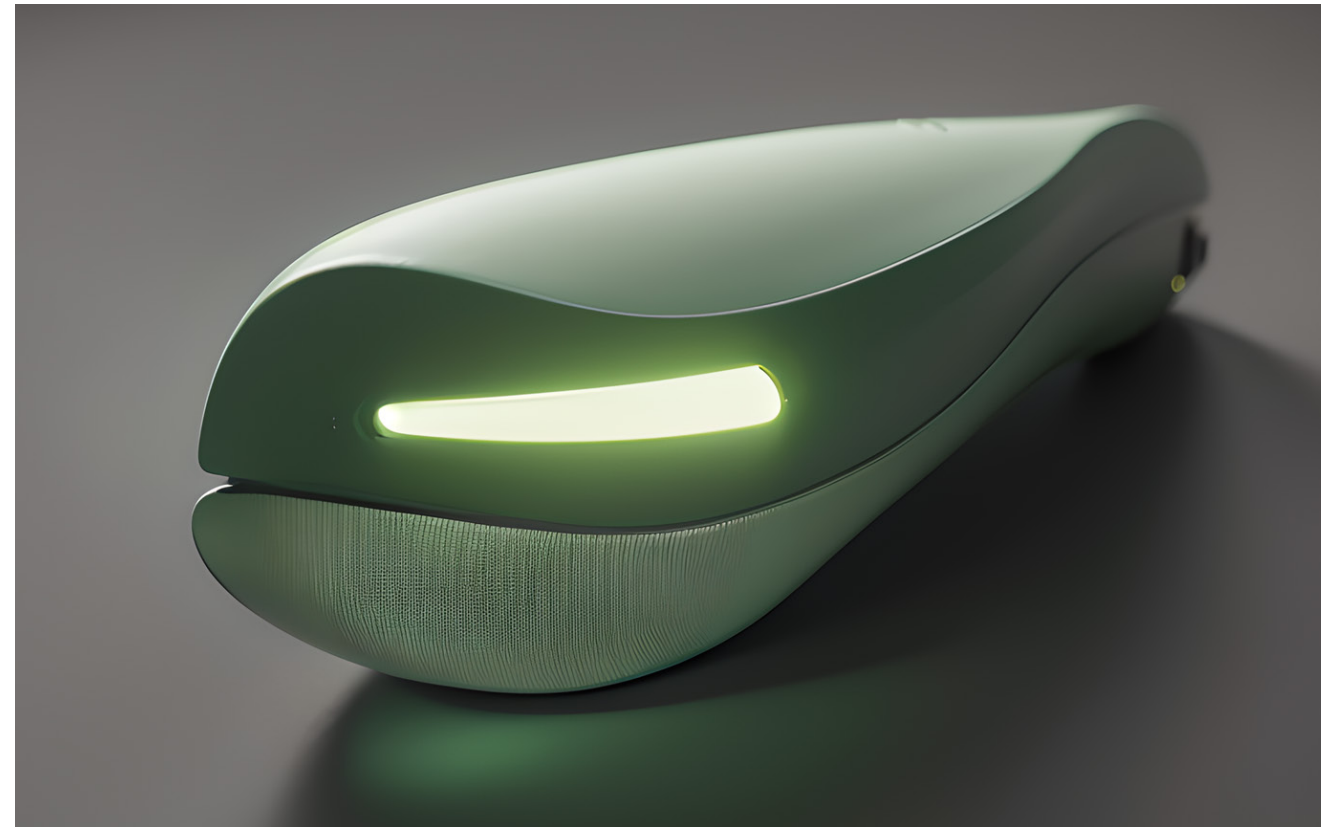
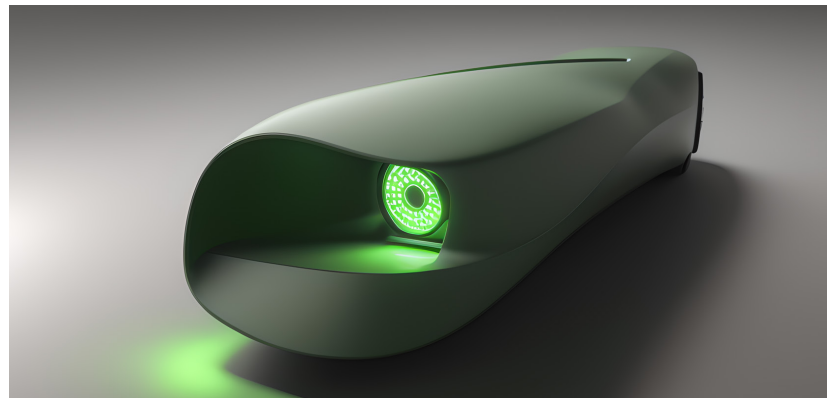
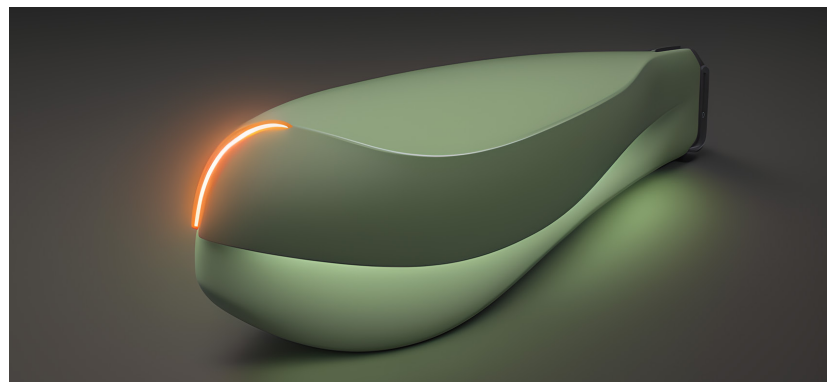
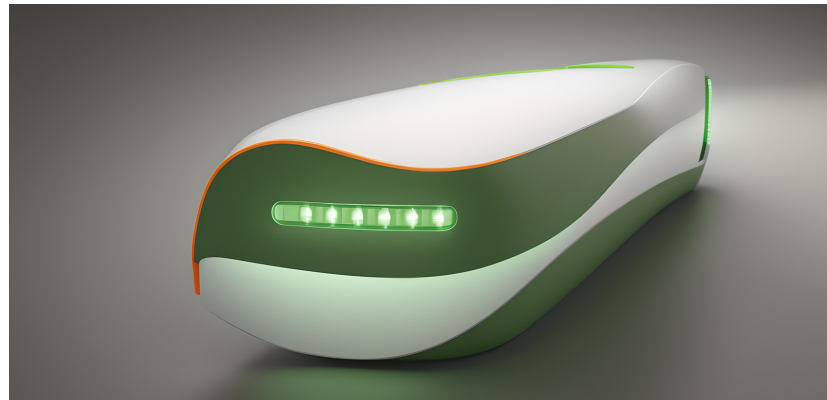
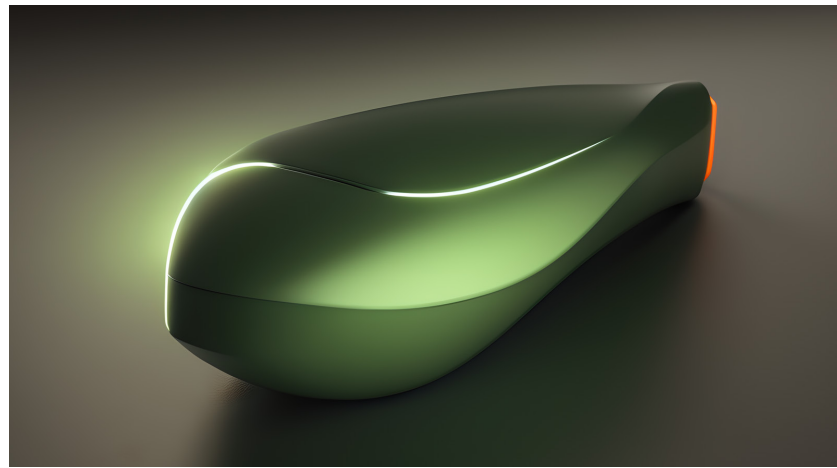
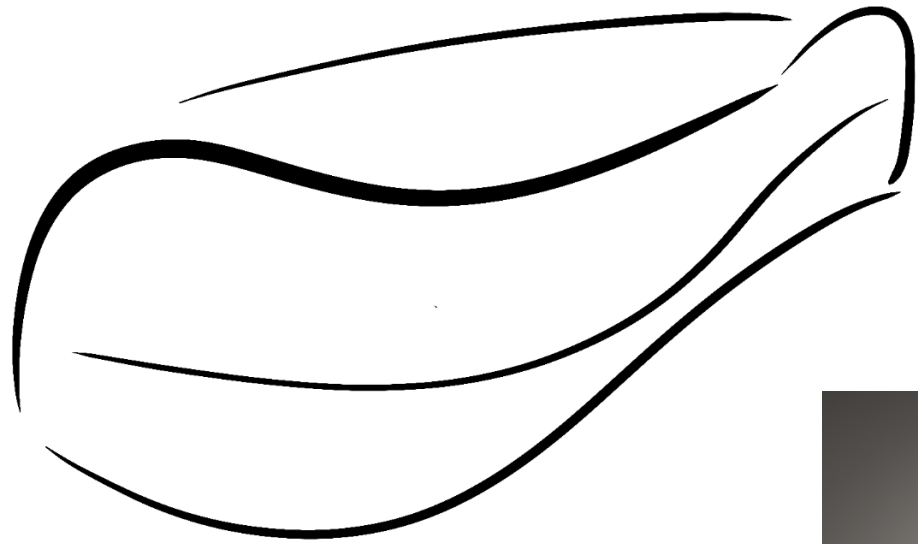

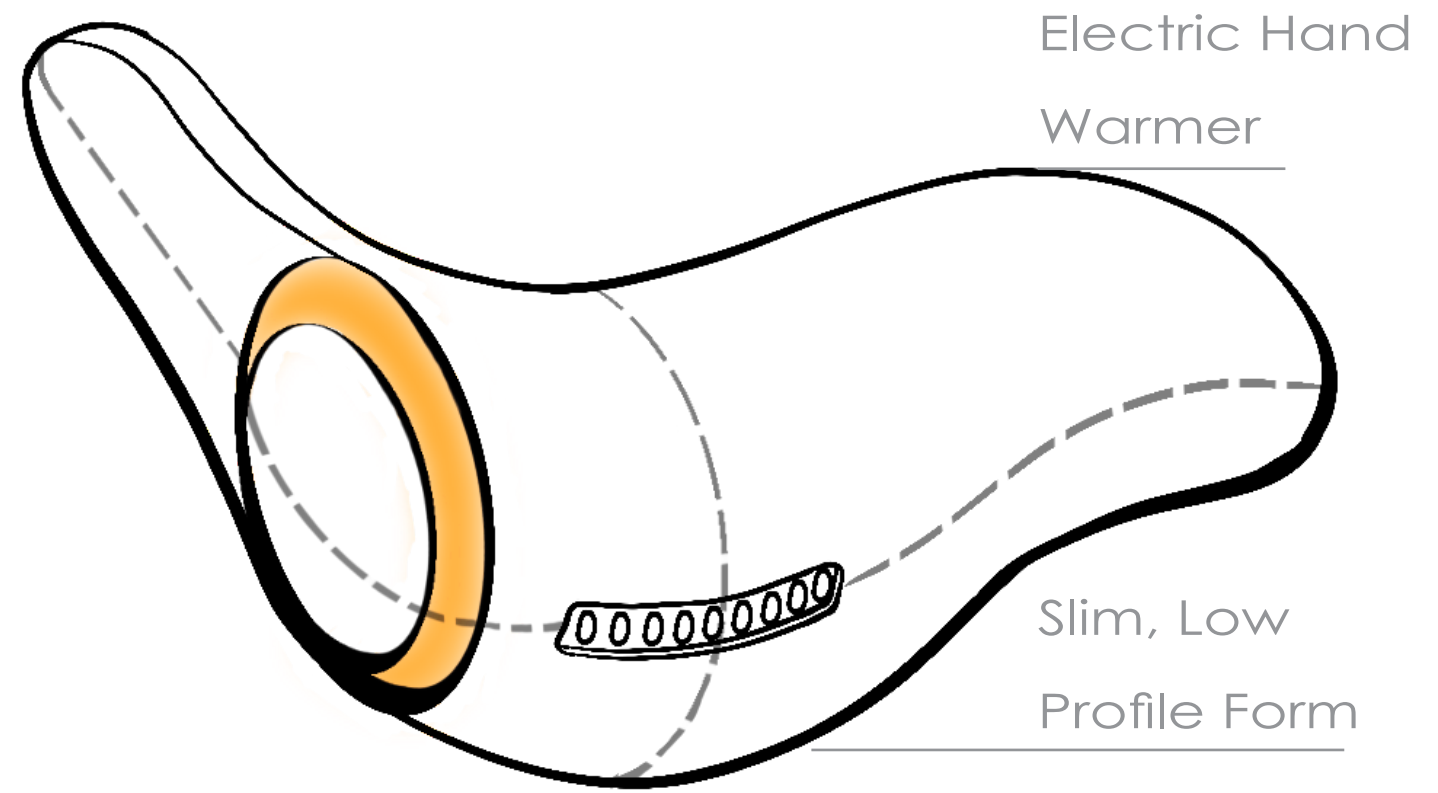
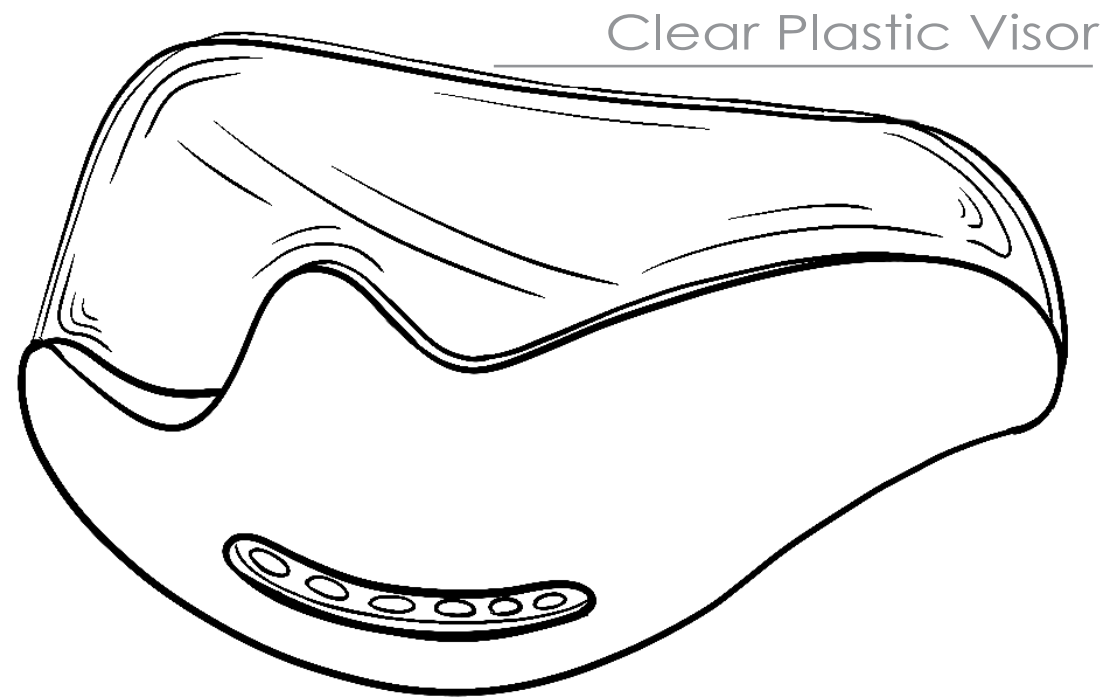
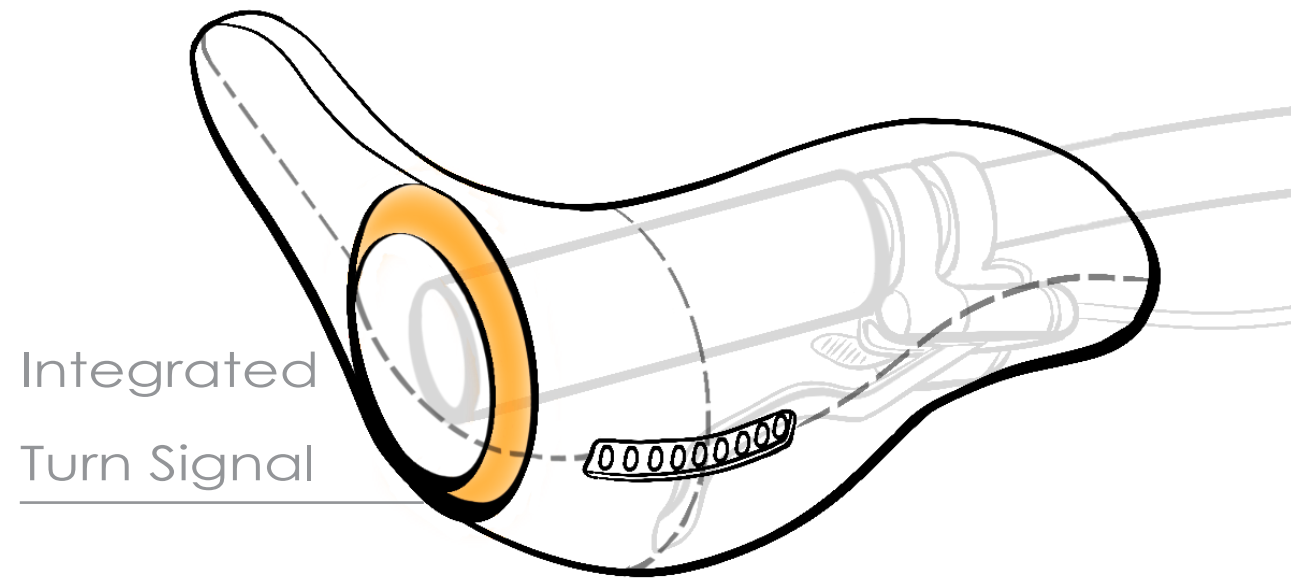
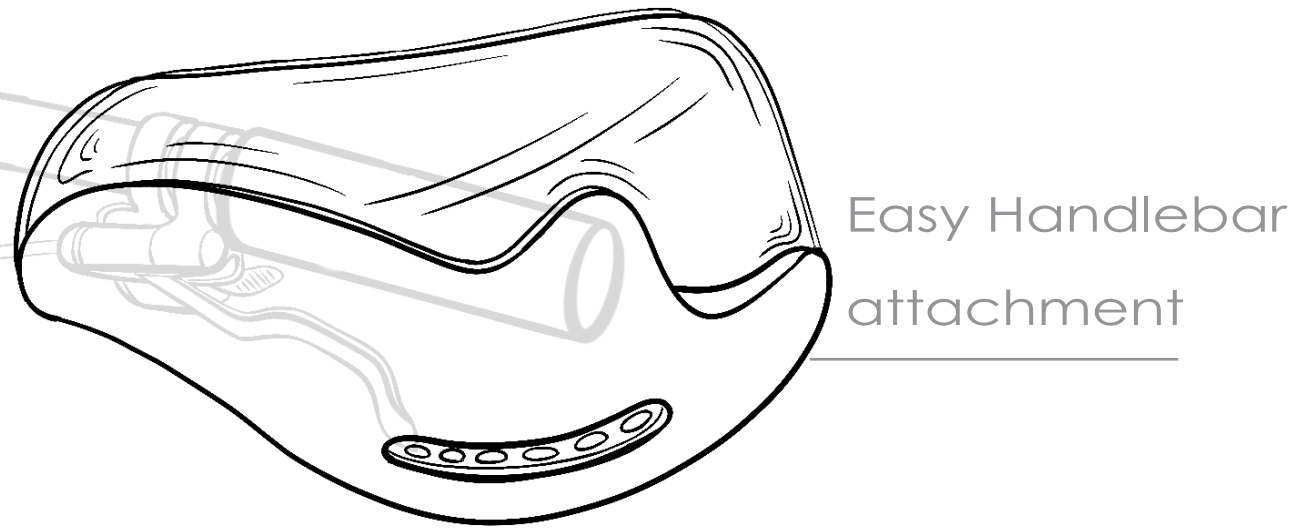

1

2

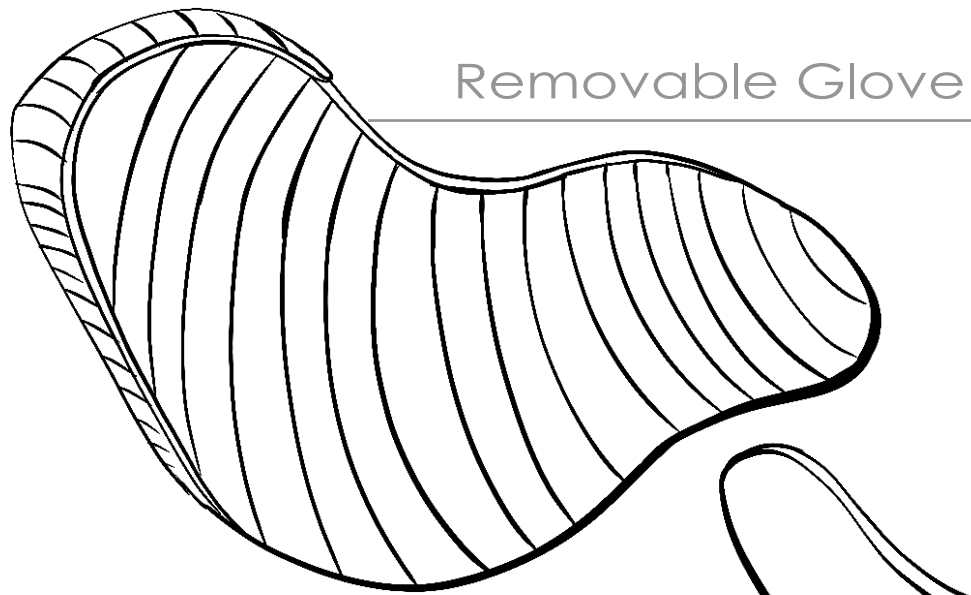
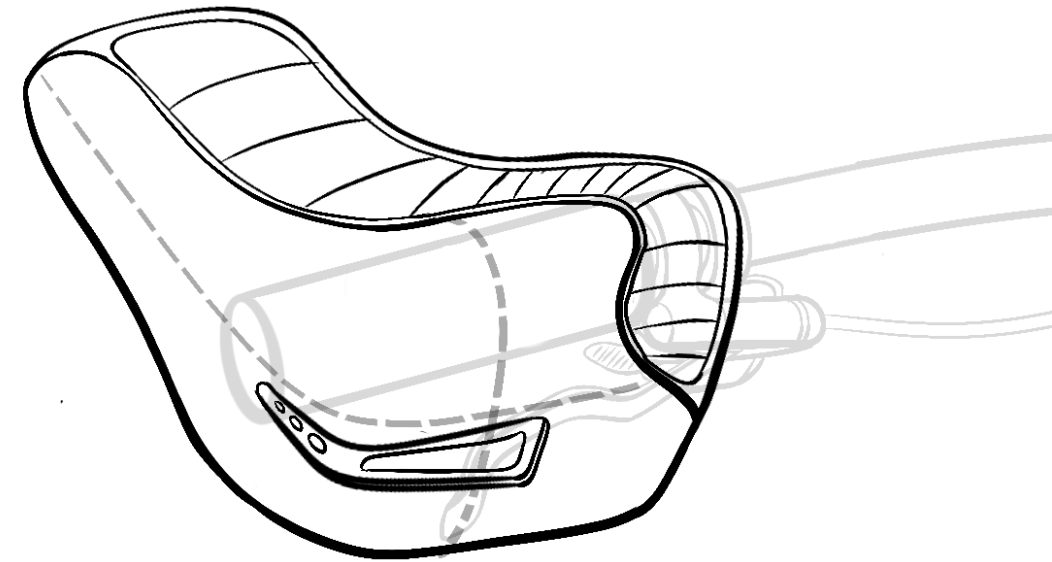
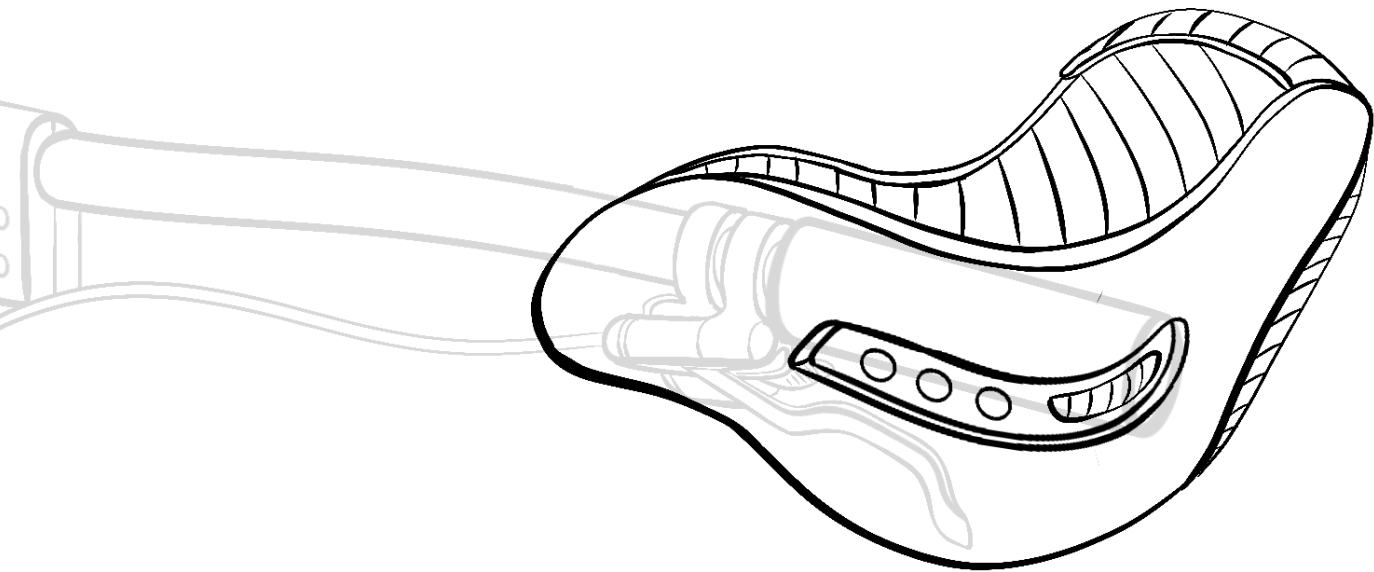

Removable Glove

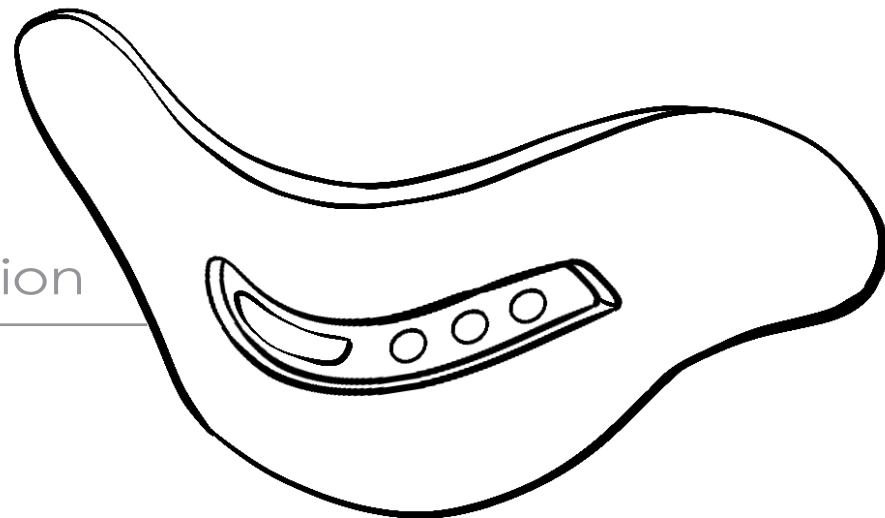

Impact Protection

3

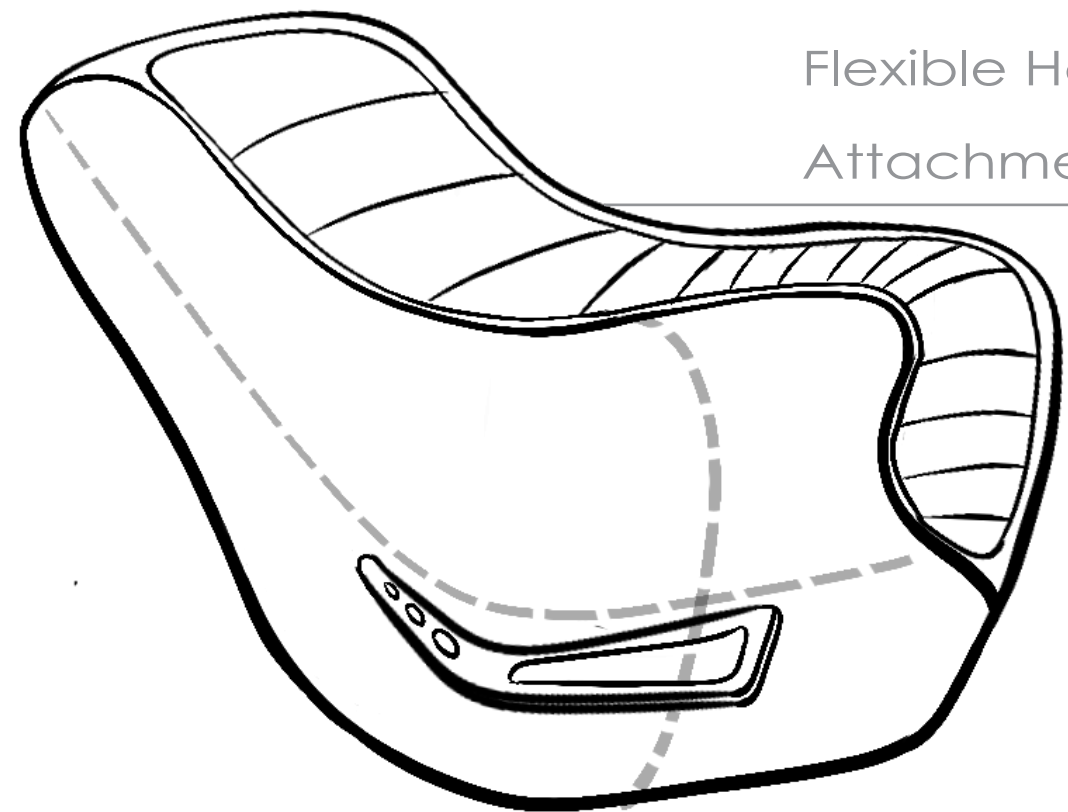

Flexible Handlebar Attachment

4

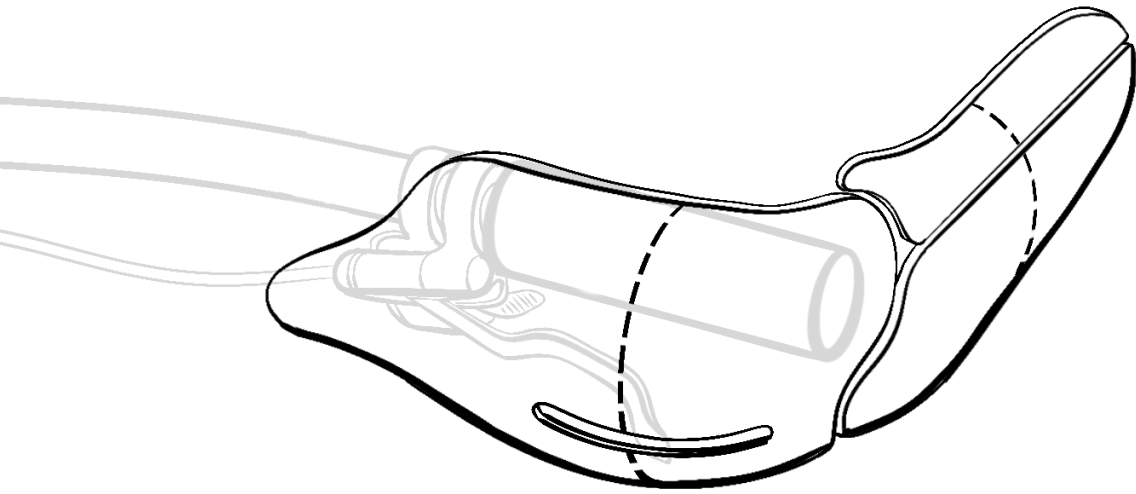

Room for Various
Wrist Angles

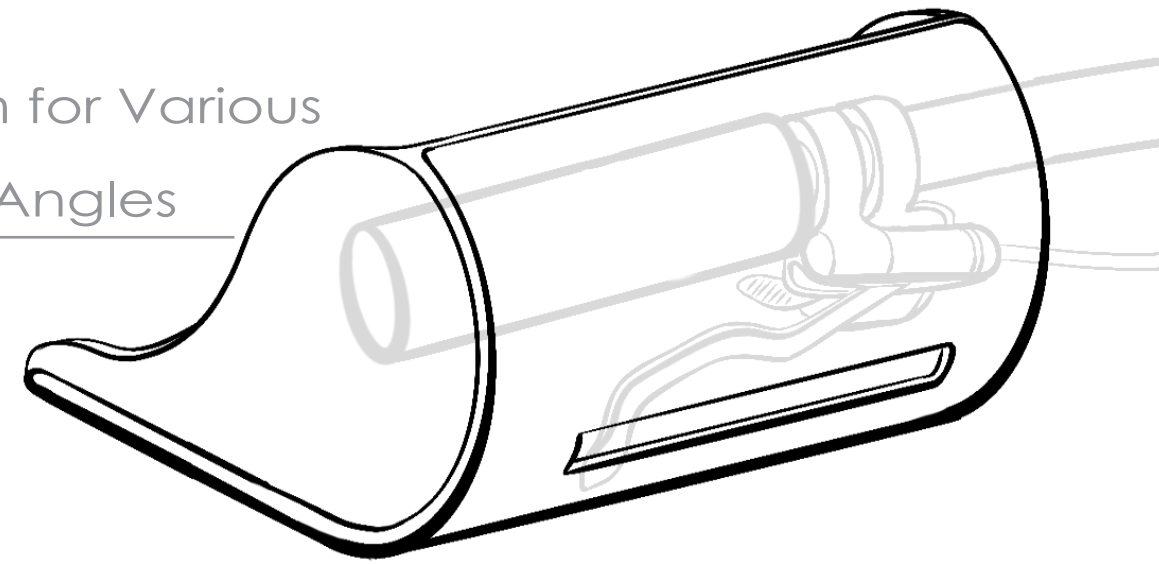

Removable
Components

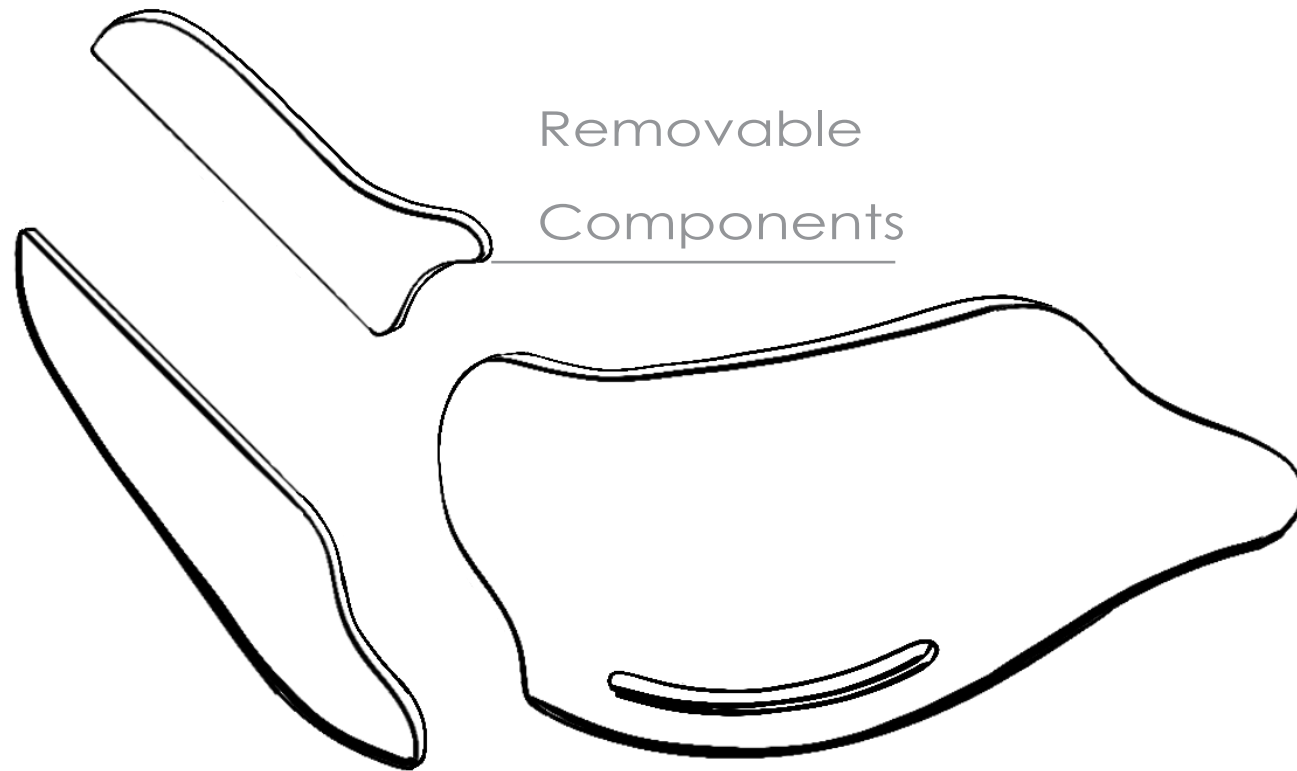

5

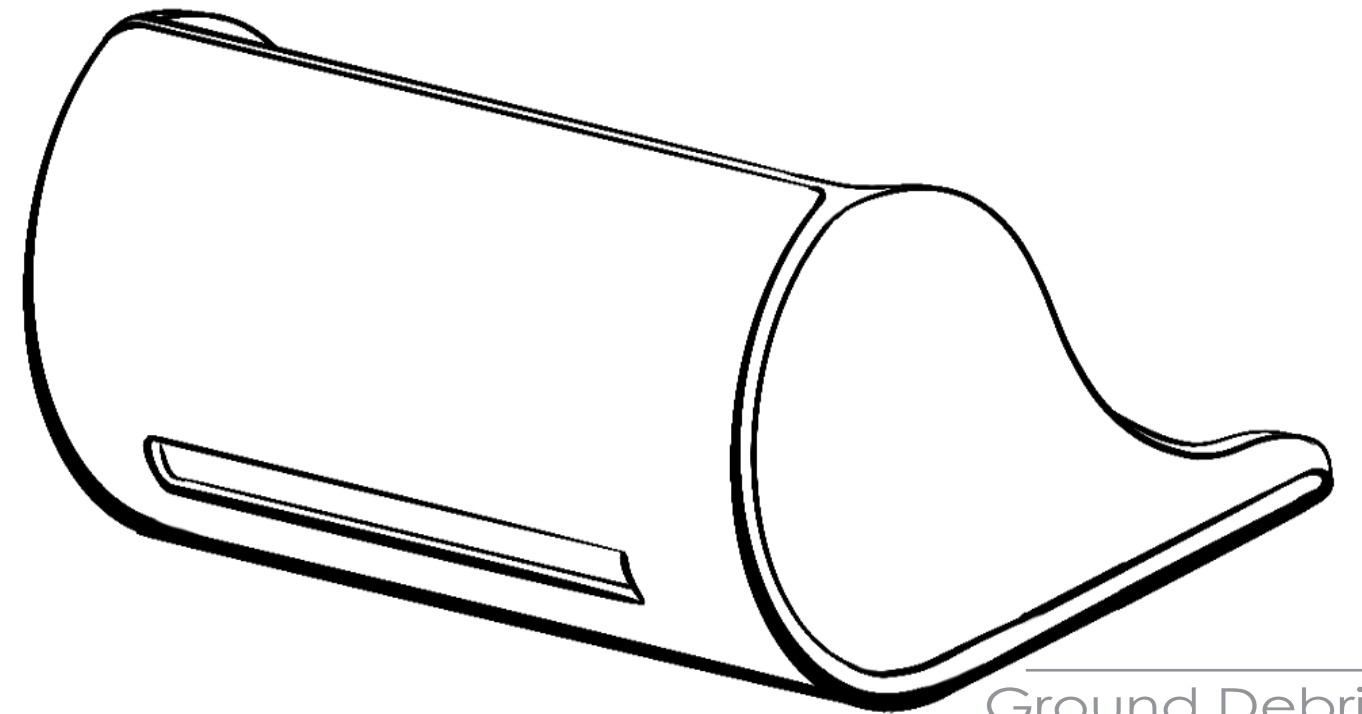

Ground Debris
Protection

6

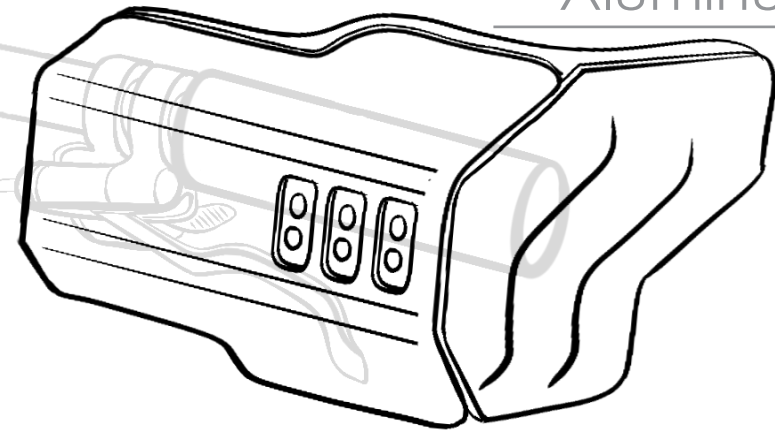

Aluminum Exterior

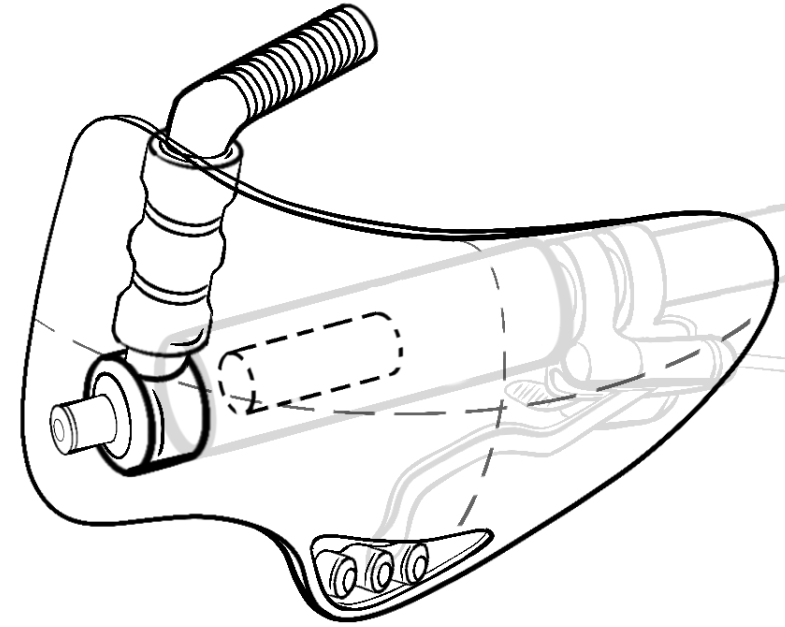

Integrated
Electric Heaters

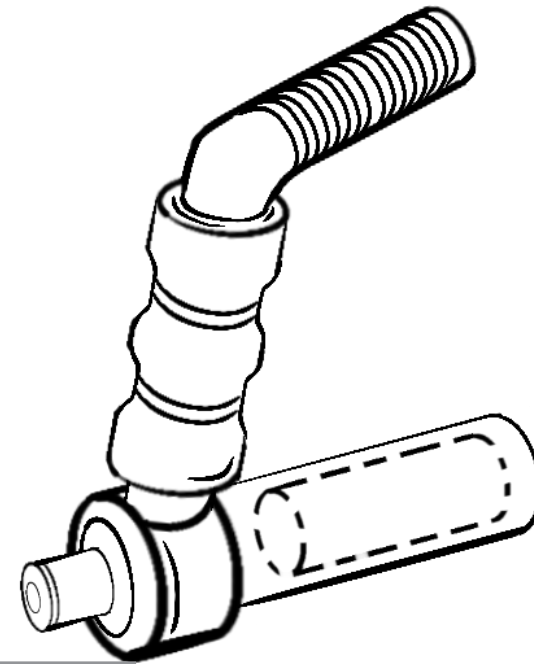

Heated Handlebar
Grip and Battery

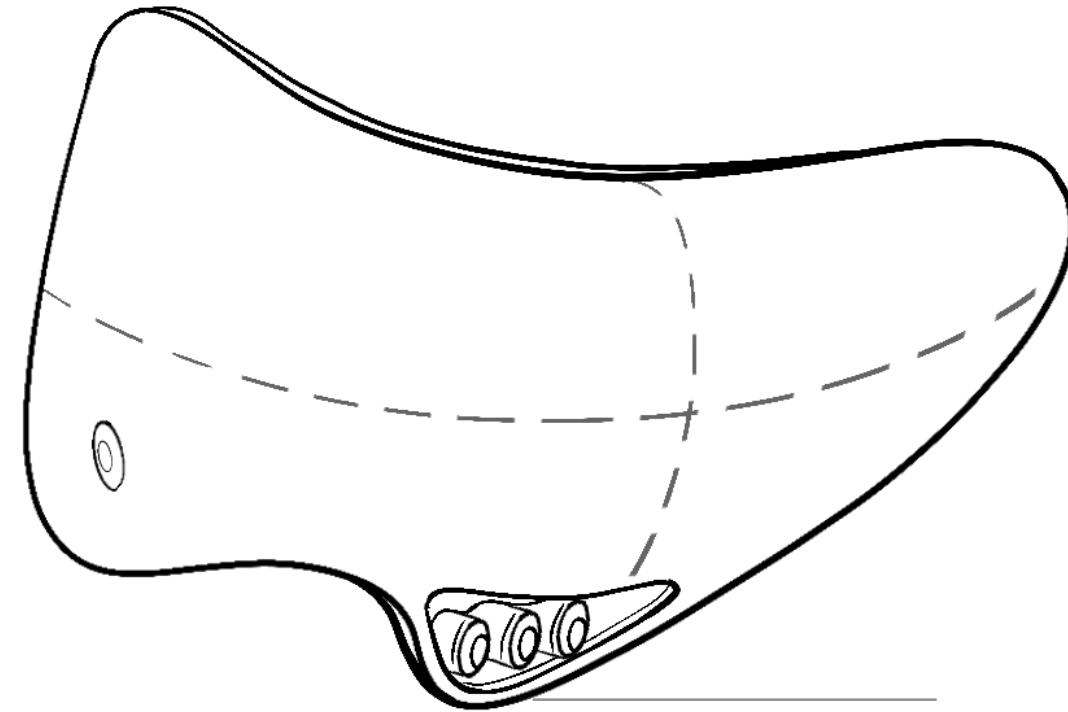

LED Flashlights

7

8

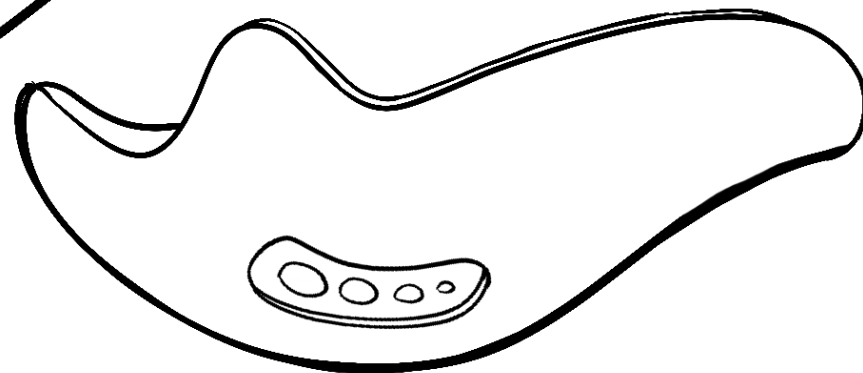
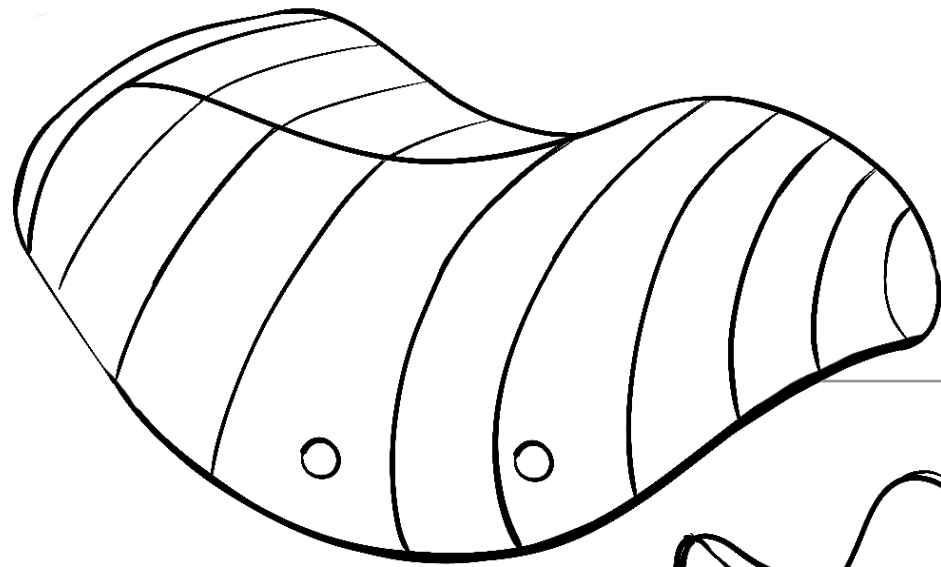
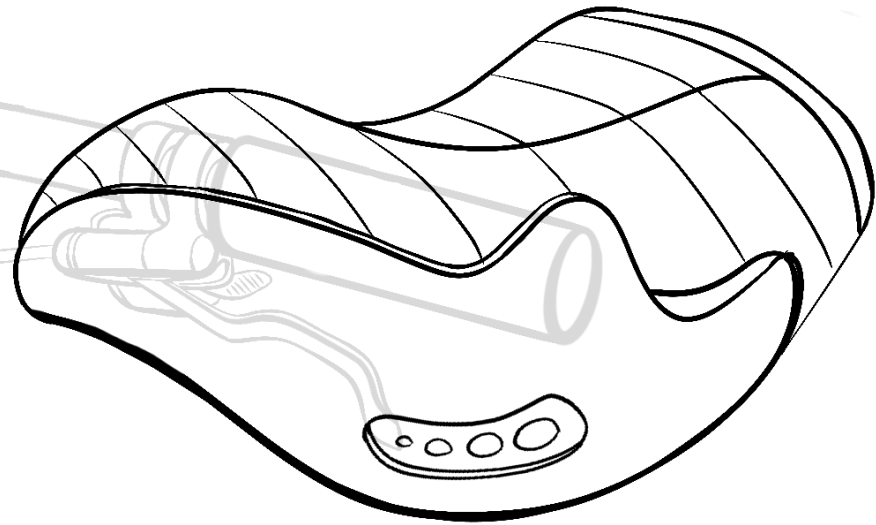

Separate Guard
And Glove

9

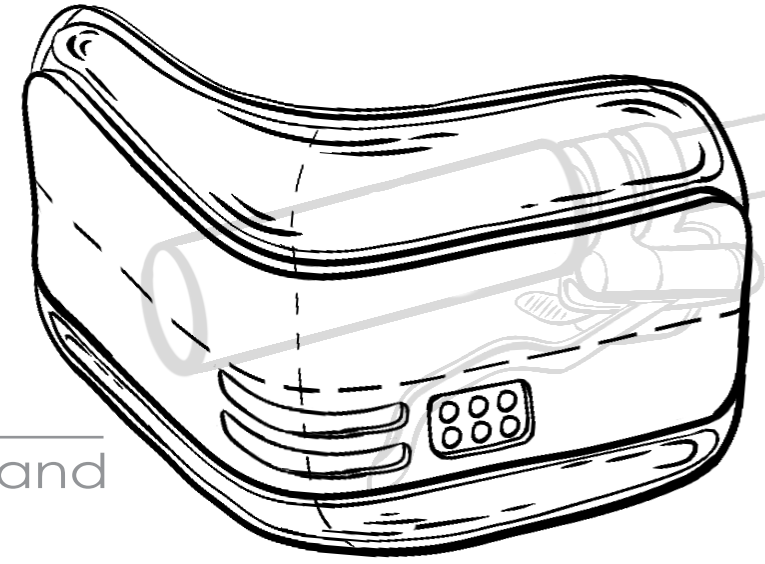

Turn Signals and
LED Lights

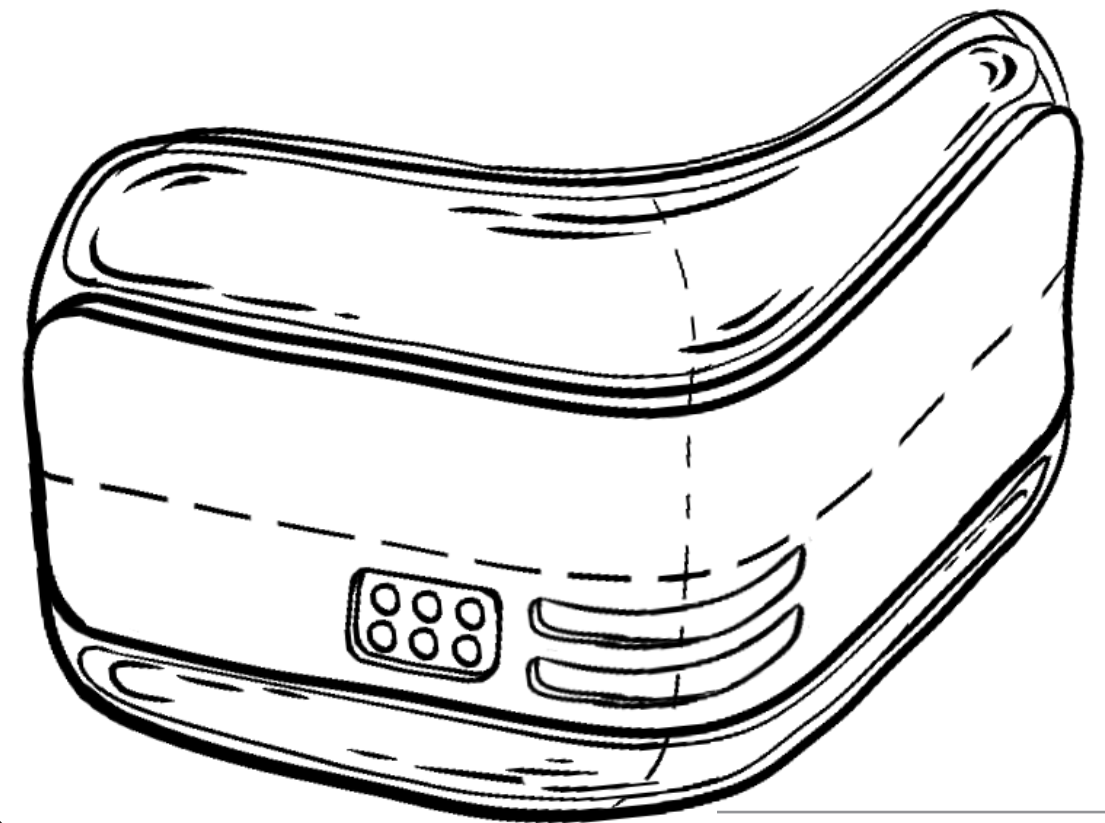

Clear Plastic

10